

WWG SDA-5000

Stealth Digital Analyzer



The Stealth Digital Analyzer (SDA) product family offers a true "One-Box" solution for HFC network testing and deployment of digital video, data, and traditional analog services. While preserving the rugged design and industry standard RF sweep technique of its Stealth Sweep System predecessor, the SDA series now adds test features to qualify the network for today's high growth subscriber services. "Find and Fix" tools are included that reduce technician time for the most labor intensive maintenance and troubleshooting assignments, like tracking down reverse ingress, optical node alignment, proof-of-performance testing and return path alignment. For these demands, the SDA provides advanced QAM analysis (optional), a powerful 5-1,000 MHz spectrum display with cable modem analysis (Zero Span), PathTrak Field View, and full forward and reverse sweep capability. And with the versatile combination of standard and optional features, the SDA can be customized for both the cable operator's network technology level and budget.

Why Sweep is the Right Solution

 The majority of all transmission errors (including digital) are found by measuring the frequency response of the network. Every

physical error in the network that influences the transmitted signals will be revealed in the sweep trace. This means the sweep results are independent of transmission methods and formats.

The goal is to transmit all signals with the best noise specifications and the lowest intermodulation distortion. Sweep is the most effective and efficient tool to show the best compromise between the two. In other words, sweep helps you to setup the right gain versus frequency.

Normalized Sweep. To ensure that network specifications are maintained, starting from the headend to the subscriber, each section of the network has its own set of specifications. A normalized sweep divides the network into easy manageable sections. Each network section can be designated to an individual team or contractor, with its own set of specifications and quality requirements.

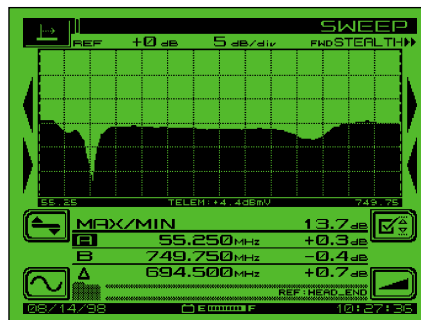

▲ Forward sweep display revealing severe problems at the low frequency end.

The SDA series uses a variation of the original Stealth Sweep technology. Existing video carriers (analog, digital, or scrambled) are referenced when possible, eliminating any possibility of interference to the subscriber services. Where carriers are absent, the SDA-5500 Transceiver at the headend transmits a sweep to fill vacant spectrum areas. To remove effects of headend level drift, the SDA-5500 Transceiver monitors the levels and transmits new reference information with every sweep. This means if the signal levels are changing in the headend, they won't effect the sweep response measurement. The SDA-5500 Transceiver has all of the measurement capability of the SDA-5000 Receiver, therefore the Headend Technician can keep an eye on headend levels.

- Digital Ready, Non-Interfering, Continuously Referenced Sweep
- Forward and Reverse Sweep in One Hand-Held Instrument
- Optional QAM View Provides Complete Analysis of Digital TV and Forward Cable Modem Signals
 - > Pre/Post FEC BER
 - > MER
 - > Constellation
 - > Exclusive "Ingress Under the Carrier"
- Fast, Sensitive Spectrum Analyzer
- Cable Modem Analysis Using Zero Span Mode Provides Accurate, In-service, Power and CIN Measurements
- PathTrak Field View Option Quickly Pinpoints Return Path Noise / Ingress
- Automated 24 Hour Proof-of-Performance According to FCC and CENELEC Standards
- International Language
- Rugged, Weather Resistant and Lightweight

The SDA series also offers significantly faster forward sweep speed, especially in systems that include many digital signals. The SDA is capable of referencing 64/256 QAM signal types, so there is no need to worry about subscriber interference or injecting sweep carriers in the guard bands.

Stealth Sweep and SDA Series Sweep Compatibility. The SDA series is completely sweep compatible with Stealth 3SR, 3ST, 3HRV and StealthTrak SSA-1000 series meters. The only requirement is that firmware version 9.3 is installed in Stealth Meters, and firmware version 2.0 installed in StealthTrak SSA-1000 meters. Additionally, in order to take full advantage of the faster forward sweep capability, all headend and field instruments must be SDA series.

Preparing the Network for Interactive Services

Reverse Sweep. The SDA-5000 (with OPT 1 installed) allows simple and practical testing of the reverse path frequency response, regardless of the frequency (5 to 1,000 MHz). And the SDA has a built-in reverse sweep transmitter, which means externally generated carriers are not required. Furthermore, the SDA-5500 transmitter and field receivers have frequency agile telemetry. They can be configured to communicate on both the forward and reverse paths.

Forward (downstream) and reverse (upstream) path alignment can be done

simultaneously by one person. The operator simply indicates which screen he wants to see—the response from the headend to the test point, or the response from the test point to the headend. A reverse sweep can uncover mismatch problems, which reveal themselves as standing waves, or diplex filter roll-offs that can severely hamper the quality of services in the reverse band.

Multiple User Reverse Testing. For intense reverse testing requirements, the rack mounted Model SDA-5510 Headend Reverse Sweep Manager handles the reverse sweep job for up to ten different technicians on the same cluster of nodes. Using the SDA-5510 in conjunction with the model SDA-5500 Transceiver provides a full forward and reverse sweep alignment solution. The SDA-5510 can also stand alone in remote hub-sites for dedicated reverse alignment applications.

Portable Reverse Sweep Manager. The portable version of the SDA-5510 allows technicians to install a multiple user Reverse Sweep Manager in locations where it is not practical to install a rack mount unit. The SDA-5000 with OPT 6 provides all the functionality of the SDA-5510, but in the rugged SDA-5000 field unit package. Applications include installation in systems where reverse traffic is received by an ATM/SONET/SDH network rather than returning to the headend, or any condition that prevents rack mount installation or access to a headend/hub-site (Note: Forward sweep capability not included with SDA-5000 with OPT 6).

SDA instruments provide a comprehensive set of measurement tools that will follow the expansion of your cable network.

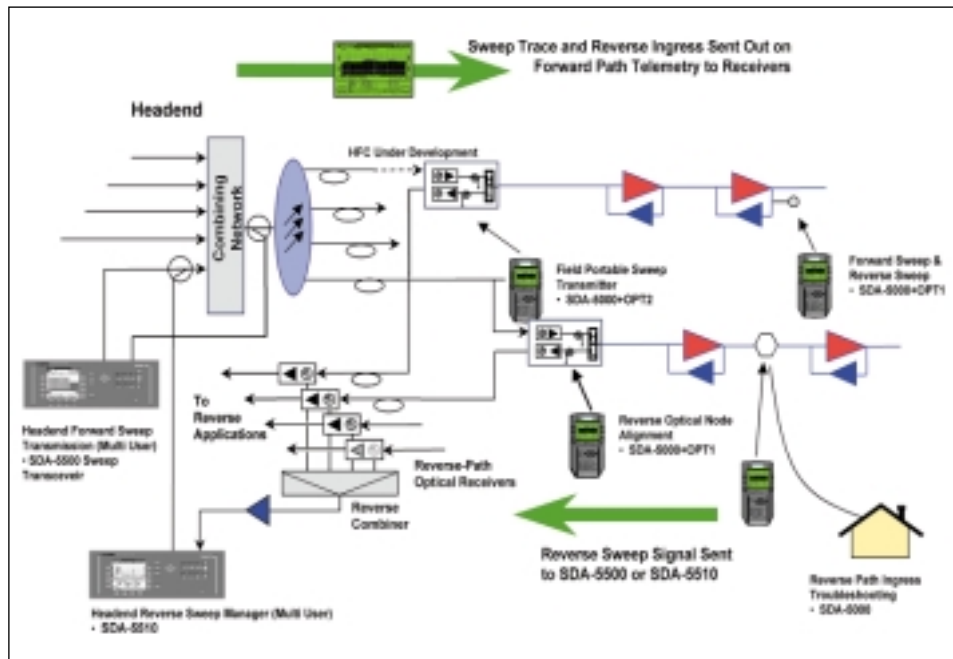

Seeing Headend/Hub-Site Accumulated Ingress in the Field. The reverse noise feature of the SDA-5000 enables easy reverse path noise testing. The operator simply presses the "Noise" soft key while reverse sweeping, and the display changes to a noise/ingress response indicating the noise level over the entire reverse path spectrum measured at the headend or hub-site. All SDA transmitters provide feedback to the field regarding the current condition of noise and ingress in the headend, even when noise or ingress is "swamping" the telemetry (broadcast mode). A "picture" of the headend noise/ingress is sent out to the receiver via a special forward telemetry carrier.

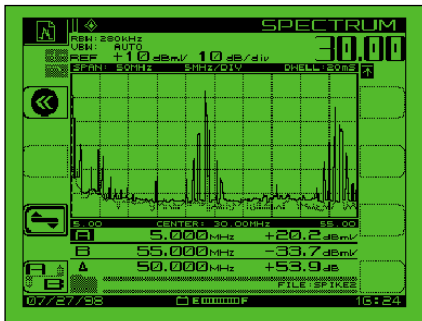

▲ Reverse ingress spectrum display.

QAM View Ensures Quality Forward Path Digital Services. For measurement and analysis of digital TV and forward modem signals, the new digital QAM View option provides a full complement of digital quality measurements. Included is a 64/256 QAM constellation display with zoom, average digital power level, Bit Error Rate (BER), 21 to 35 dB Modulation Error Ratio (MER) and noise margin "cliff effect" parameter. An equalizer display shows equalizer stress and distance to fault.

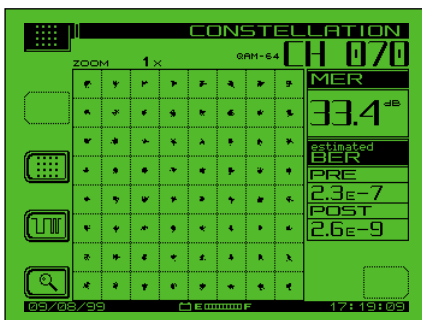

▲ Constellation display with MER and pre/post FEC BER.

In addition, an exclusive noise mode allows technicians to see ingress/noise under an active digital carrier. This tool is invaluable for detecting forward path ingress otherwise hidden by conventional spectrum views!

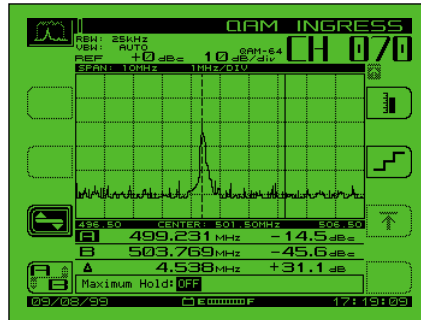

▲ QAM ingress feature shows noise/ingress under an active carrier.

Measuring the Behavior of DOCSIS Compatible Cable Modem Signals in the Cable Plant. For "bursty" digital signals, such as TDMA technologies used on cable modems for reverse services, the SDA-5000 uses the advanced Zero Span capabilities to make the measurement. Time domain displays of TDMA signals allow power measurement, D/U (desired/undesired measurements), and detection of packet collisions, all while the modem is in service. Technicians can measure the level of interference in the actual channel being used.

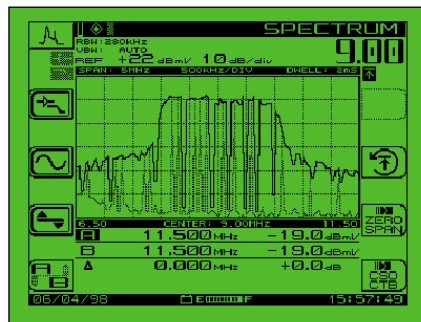

▲ Reverse digital modem signal.

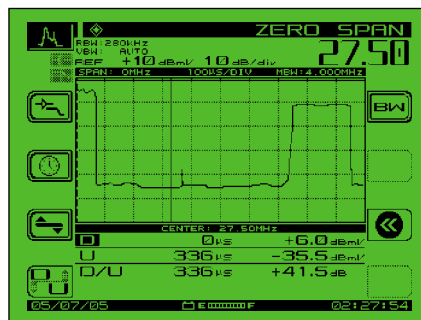

▲ Cable modem analysis using Zero Span mode provides accurate, in-service, power and C/N Measurements.

"One Box" Solution

How many test instruments should the network maintenance technician carry? One. A lightweight, rugged and affordable meter with the versatility to test the latest digital services while maintaining the analog spectrum. This "One Box" philosophy shaped the design of the SDA series, adding the analog and digital test tools most requested by field technicians and system operators throughout the world.

Analog Testing

- Forward RF Sweep
- RF Level, Fast Scan, Tilt
- In-service Carrier to Noise, HUM, Depth of Mod.
- Fast Spectrum Display with CTB/CSO
- Auto Testing/24 Hour Testing (FCC & CENELC Compliant)

Return Path Testing

- Reverse RF Sweep
- PathTrak Field View (Option)
- Reverse Alignment Mode Prepares Network for Cable Modem Deployment
- Zero Span Spectrum Mode
- DOCSIS/DAVIC Compatible Cable Modem Analysis

Advanced Digital Testing

- DigiCheck™ Average Power
- QAM View Digital Analysis with MER, Pre/Post FEC BER, Constellation, and Exclusive Noise / Ingress Under the Carrier Measurement

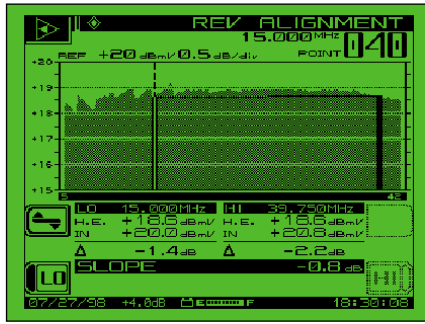

▲ Reverse alignment mode prepares network for cable modem deployment.



Detecting Ingress in the Field.

The operator looks at the ingress present at the field test point using the spectrum display on any of the receivers, then switches to reverse ingress/noise to see the ingress at the headend for comparison. This time-saving procedure helps in locating sources of ingress. An adjustable dwell time ensures that even intermittent ingress is detected. The pre-amp and low-pass filter also assures that even low-level ingress is seen. The pre-amp and low-pass filter on the SDA-5000 assures that ingress can be measured on devices with bi-directional test-points or testpoint values of 30dB or more.

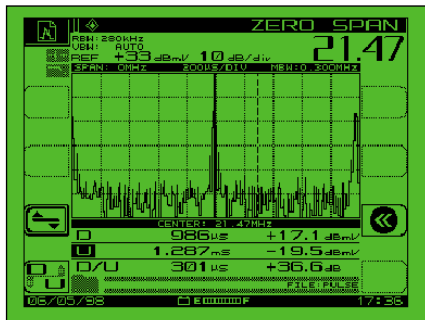

▲ Time domain view of ingress in the Zero Span mode captures elusive ingress.



PathTrak Field View.

When your system is equipped with the PathTrak Performance Monitoring System, system technicians can benefit from the ultimate ingress fighting tool—the PathTrak Field View option for the SDA-5000. With Field View, The SDA-5000 receives a return path headend spectrum broadcast from the PathTrak unit, and then compares it with a return path spectrum at any field testpoint. The side-by-side spectrum comparison instantly reveals to the technician whether the ingress source is originating at his current testpoint or at a different location. The comparative spectrum technique slashes noise/ingress troubleshooting time, since

the technician can immediately verify whether corrective action performed in the field (local trace) results in improvement in the headend spectrum (remote trace).

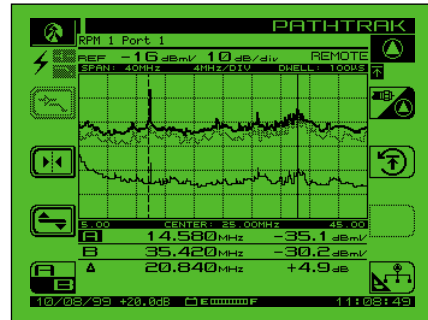

▲ PathTrak Field View option compares headend node spectrum with field testpoint spectrum.

Powerful Graphic Displays and Common User Interface Allows Technicians to Learn Fast



The results of all measurements are presented to the user in clear, highly informative, summary displays. The graphics present the information the way the technician wants to see the results – no further interpretation required. For example, testpoint compensation values are entered at the start of testing. Displays then calculate actual levels automatically, minimizing field errors.

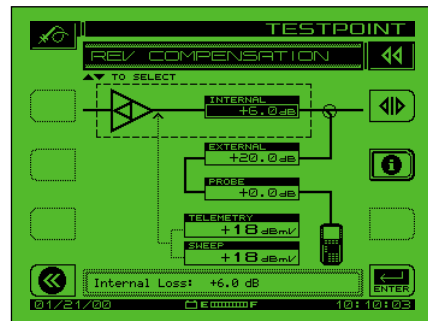

▲ Graphical reverse testpoint compensation.

With SDA series products, all levels of instruments are familiar to the technician, regardless of which is learned first, because the same user interface conventions are used across all product families (several examples of the icons are included in this literature). The learning curve for a progressing technician is considerably shorter than alternative test equipment. This means urgent upgrade projects make the most efficient use of limited resources when SDA series products are used.



▲ The Navigator user interface, common on all WWG meters.

Comprehensive Testing

The SDA provides an extensive set of signal analysis features designed for proving, and improving, network quality. All tests utilize a practical user interface, normally requiring only a one-button keystroke.

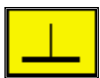

Level Measurement. The SDA instruments provide a comprehensive single-channel display with tuned channel, video frequency and level, audio frequency and level, and the difference between video and audio carrier levels.

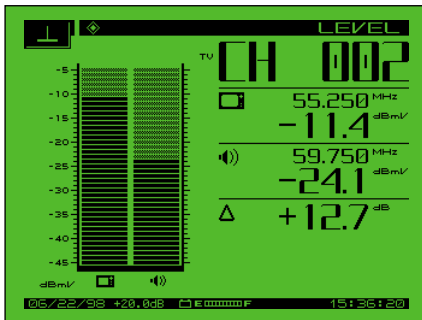

▲ The single-channel level display shows both video and audio levels (either single or dual sound/NICAM) and the difference between the two.

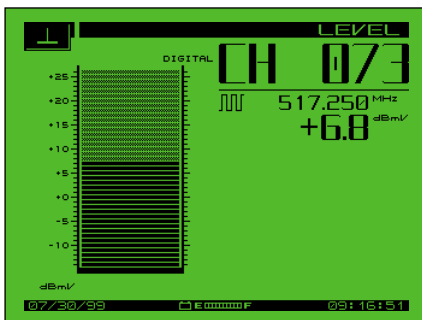

▲ Digital channel average power measurements can be made using the digiCheck™ feature.

Making accurate digital average power measurements are addressed with the digiCheck™ measurement function. The digiCheck™ feature is compatible with most "non-bursty" digital modulations in use today (i.e., 16, 32, 64, and 256 QAM, QPR, QPSK, VSB, CAP16, etc.).



Analog and Digital Signal Limits.

Analog signal threshold limits have always been a technician's favorite feature of WWG instruments. Automatic limit checks provide a quick go/no-go status for audio and video levels. The SDA series extends this capability with a dedicated digital limit set that can be applied exclusively to the forward digital carriers defined in a channel plan. By assigning separate analog and digital limits, test time is reduced since no calculation is necessary to determine if analog and digital level relationships are within system specifications. Analog and digital limit capability is available in both the scan and autotest modes (available July 2000).



Tilt Measurement.

Tilt is the easiest and most efficient tool for balancing amplifiers. For cable plants requiring multiple tilt measurements, such as comparing today's tilt measurement with a historical record, and then making an additional measurement for a new wider channel plan, the user simply uses markers to indicate the tilt channels that define the new limits.

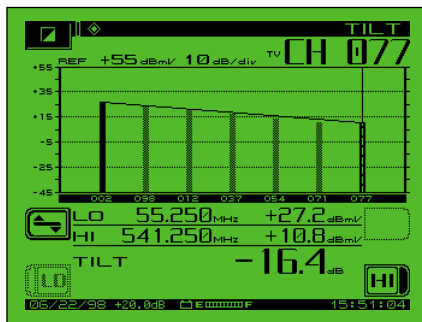

▲ Tilt mode performs automatic tilt calculations between any 2 of 9 designated carriers.



The CTB/CSO mode is used for automatically making intermodulation measurements.



Scan Measurement.

Scan mode provides a quick graphical view of the entire channel plan with bars representing the video level for each channel. Both video and audio may be displayed.

Additional Customer Support

Wavetek Wandel Goltermann offers quality, cost-effective support programs that address all of your technical support needs. With over 20 fully equipped CATV accredited service centers worldwide, WWG provides local product maintenance, calibration and upgrades, along with technical training services.

CarePlanSM Customer Support Package

The WWG CarePlan is a proactive technical support program designed to safeguard your investment throughout its complete life-cycle. Key benefits of the CarePlan include:

- Cost-effective product maintenance support
- Annual calibration certification program
- Proactive hardware and software upgrades
- Technical support

Technology Training

WWG provides a comprehensive CATV technology training program designed to help you and your teams understand the changing needs of today's advanced networks. Training seminars include:

- HFC Basics
- Understanding Digital
- Sweep and Balance Forward and Return
- Mastering the Forward Path
- Mastering the Return Path
- Sweep 101 "Bootcamp"

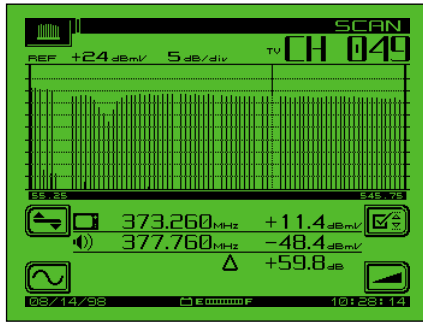

▲ Limit checks can be instantly viewed after identifying channel of interest with a marker in scan mode display.



Carrier-to-Noise Measurement: In-Service. Carrier-to-noise measurement (on non-scrambled channel) is just as easy, and there is no need to remove modulation from the video carrier. No tunable preselector filter is needed.

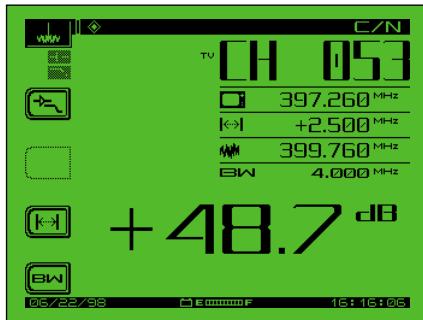

▲ In-service carrier-to-noise.



Hum Measurement: In-Service. Measuring hum on a channel (non-scrambled) is as simple as pressing the "HUM" key. And since the instrument is battery powered, the measurement is independent of ground loops, therefore isolated from the line (mains). Hum reveals itself as either single (60 Hz) or double (120 Hz) horizontal bars across the video screen. The level of either can be measured.

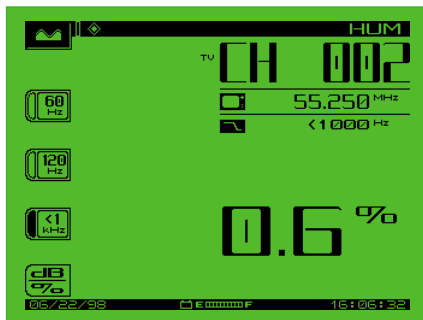

▲ In-service HUM (PAL/NTSC compatible).



Modulation Measurement. Includes NTSC, PAL and SECAM formats. Demodulation of the audio is done for both AM and FM. FM is used to hear audio distortion on the FM radio channels or the sound of the TV program. AM is used to recognize short-wave interference signals in the reverse band.

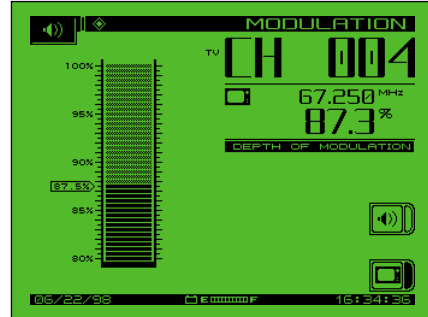

▲ Depth of modulation.



Local Amplifier Alignment with Loopback Tests. The SDA Loopback tests allow the technician to quickly perform frequency response measurements of active or passive field devices using a single meter. Either a CW or sweep signal may be generated from the SDA unit and injected to the input of a device under test. The DUT output can then be measured by the SDA, providing valuable information like gain, loss, roll-off or frequency response. The CW loopback test is available on the SDA-5000 when ordered with OPT 1. The CW loopback and Sweep Loopback features are available on the SDA-5000 when ordered with OPT 2.

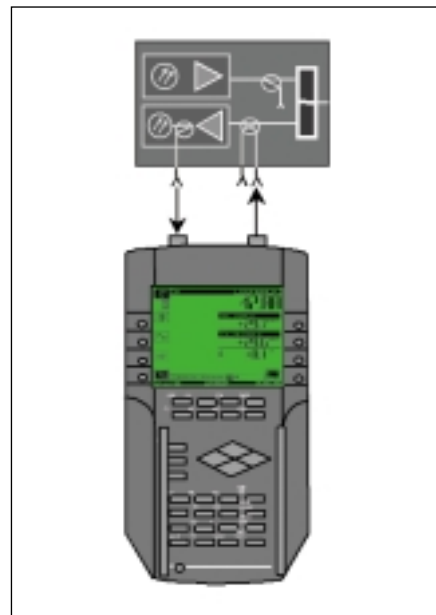

▲ Local Loopback Sweep: Performs initial setup of optical nodes or measuring the gain or loss of individual components in the field.

Extensive Automated Test Capability

Automated tests can be scheduled to perform either 24-hour FCC compliance tests, or initiated immediately to log performance at individual nodes, amplifiers, or other testpoints. A wide range of tests can be performed automatically, including signal levels, C/N, hum, and depth of modulation. The operator designates which tests to perform on which channels. Because these tests are non-intrusive, it is easy to test all parameters on all channels at anytime.

After a test is performed, the results can be displayed on the SDA screen. A pass/fail indication on a variety of limits can be set for FCC/CENELEC or other government standards, or to system preferences. Data taken during any automated test, or sequence of automated tests, can be viewed immediately with a pass/fail indication for each of the limits. Specific stored measurement results may be viewed on demand. Automated test results can be printed directly to a serial printer or uploaded to a PC using StealthWare to store and include in custom reports.



▲ The detailed forward or reverse sweep graph offers user-adjustable markers, scale, reference level, and tilt. Users can clearly distinguish the difference between previous and current sweep measurements for easy comparison on the PC StealthWare display.

Data Analysis with StealthWare

Any stored SDA measurement information can be up-loaded to a PC using StealthWare, a Windows™ based data management package. Stored sweep, scan, or spectrum screens can be viewed on the PC and analyzed with marker movement and readout information just the same as on the actual unit. A sweep graph overlay function allows comparison of multiple RF response variations over time. Old sweep graphs may

be downloaded back into the SDA instrument for real-time comparison.

StealthWare also allows the operator to build channel plans and edit site locations, which can be downloaded to multiple SDA instruments. Additionally, channel plans can be uploaded to the PC, modified in StealthWare, and then downloaded back to the SDA instrument.

Upgrading from Stealth to SDA Series

Your test equipment investment is protected through the WWG upgrade program. Any model 3SR, 3ST or 3HRV can be upgraded to the SDA series at any of our worldwide service centers. And if you own a model SSA-1000, you can upgrade to the SDA series with an in-the-field firmware change only!

Start with any SAM 4040 or 4040D
Optional: PathTrak FieldView (4040D)

SAM 4040D OR SAM 4040

a) Firmware b) Hardware & Firmware

Upgrade to SDA-4040D
Standard: DigiCheck, ZeroSpan, Dig Spectrum
Optional: PathTrak FieldView, QAM View
Add **Option 4** for: QAM View

WWG SDA-4040D

QAM View option

Any Stealth can upgrade to SDA-5000 for:
5 x faster sweep
256 QAM compatible sweep
Improved TP Comp setup for reverse sweep

SSA-1000 OR 3SR

a) Firmware b) Hardware & Firmware

SDA-5000 units can be purchased with, or upgraded to:
QAM View
PathTrak Field View

WWG SDA-5000

QAM View option

Any 3ST can be upgraded to SDA-5500 for faster forward sweep and digital signal sweep compatibility
Any 3HRV can be upgraded to SDA-5510.

3ST OR 3HRV

WWG SDA-5500 OR WWG SDA-5510

Stealth to SDA Series – Product Upgrade/Replacement Guide

Stealth Model	SDA Replacement
3SR	SDA-5000
3SR + 3SRV option	SDA-5000 with Option 1
3SR + 3SRT option	SDA-5000 with Option 2
3ST	SDA-5500
3HRV	SDA-5510
SSA-1000	SDA-5000 with Option 1 (firmware only)
SAM 4040	SDA-4040D
SAM-4040D	SDA-4040D (firmware only)

Other SDA Materials Available:

The following WWG materials are available. Inside the U.S., please call toll-free at 800-622-5515 or 317-788-9357. For faster service, please visit our website at www.wwgsolutions.com.

- Wavelengths newsletter
- SDA Series Color Sell Sheet
- PathTrak Field View Option "How It Works"
- App Note #1, Forward Sweep and Balance
- App Note #2, Reverse Sweep and Balance
- App Note #3, Return Path Troubleshooting
- SDA-5000 Sweep Training CD-ROM

Application Features

APPLICATION	FEATURE	SDA-5000	SDA-5500	SDA-5510
Full frequency response testing	Forward Sweep using headend transmission	•	•	
Reverse path alignment for new digital services	Reverse Sweep	•		
Prepare for cable modem deployment	Reverse Alignment Mode	•		
View return distortion and ingress as captured at headend	Reverse Ingress/Noise PathTrak Field View	•	•	
Reverse path ingress troubleshooting	Built-in low-pass filter and preamp, dwell time	•		
Handle multiple reverse path sweep tests at one time	Multiple User Reverse Sweep reception (up to 10 simultaneous users)			•
Pro-active reverse path maintenance capability	PathTrak Field View option	•		
Forward sweep without headend support	Sweepless Sweep using carrier levels only	•		
Forward path sweep carrier transmission	Forward transmission of sweep carriers	•	•	
Quick scan of active channel plan	SCAN mode w/Limit Check	•	•	•
View local distortion and ingress	Spectrum Display	•	•	•
View and measure cable modem carriers on return path (DOCSIS/DAVIC)	Zero Span TDMA Time Domain Mode	•	•	•
Test forward path digital services	digiCheck™ and QAM view option	•	•	•
CSO/CTB Measurements	CSO/CTB mode	•	•	•
Amplifier checks and alignment	TILT mode	•	•	•
Local Amplifier and Optical Node Alignment	CW Loopback (opt. 1 or 2) Sweep Loopback (opt. 2 only)	•		
In-service Carrier-to-Noise Measurement	C/N mode	•	•	•
Analog and Digital Level Measurements	LEVEL mode digiCheck™ Mode	•	•	•
Depth of Modulation Measurements	MOD mode	•	•	•

Model SDA-5000:

Forward and reverse sweep field receiver with advanced signal analysis. Compatible with older Stealth units running firmware version 9.3. Includes: Extended-life nickel metal hydride battery, universal charger/AC adapter, canvas carrying case and operators manual.

Model SDA-5500:

Headend Sweep Transceiver: Provides forward sweep and single user reverse sweep for SDA-5000. Compatible with older Stealth units running firmware version 9.3. Includes: Line cord, channel plan transfer cable, and operators manual.

Model SDA-5510:

Headend Reverse Sweep Manager: Receives reverse sweep from up to 10 SDA-5000 receivers with OPT 1 or 2 installed. Compatible with older Stealth units running firmware version 9.3. Includes: Line cord, channel plan transfer cable, and operators manual

Options:

SDA-OPT1: Reverse Sweep capability for model SDA-5000

SDA-OPT2: Reverse Sweep capability and 5-1000MHz transmitter for model SDA-5000

SDA-OPT3A: PathTrak Field View Interoperation for model SDA-5000 or SDA-5500 (requires PathTrak HCU)

SDA-OPT4A/B: QAM View digital analysis including 64/256 Constellation, MER, Pre/Post FEC BER, and exclusive QAM ingress under the carrier feature. Please specify OPT version 4A or 4B when ordering.

SDA-OPT4A: 64/256 QAM, DVB-C, ITU-T J.83 Annex A

SDA-OPT4B: 64/256 QAM, DVS-031, ITU-T J.83 Annex B

SDA-OPT5: BNC connectors replace standard F type connectors

SDA-OPT6: Portable Reverse Sweep Manager converts SDA-5000 to hand held version of the SDA-5510 (does not include forward sweep capability).

StealthWare: Windows™ Compatible Data Management Software for all SDA, Stealth, MicroStealth, and CLI products.

Optional Accessories:

SDA-CASE1: Replacement soft carrying case for all SDA instruments without QAM View option installed.

Compatible with standard and extended life batteries.

SDA-CASE2: Replacement soft carrying case for SDA-5000 with QAM View option installed.

SDA-NIMH: Spare extended life battery.

SDA-NIMCA: Universal charger/AC adapter for extended-life nickel metal hydride battery.

SDA-NIMK: Extended life battery kit. Includes extended life battery, universal charger/AC adapter and soft carrying case (SDA-CASE1).

Specifications

NOTE: All specifications apply to SDA-5000, SDA-5500, and SDA-5510 unless otherwise noted.

Frequency

Range 5 to 1,000 MHz
Accuracy ± 10 ppm at 25°C; ± 10 ppm drift over temp.;
 ± 3 ppm/year aging
Resolution Bandwidths 30, 280 kHz and 2MHz
(30 kHz for CTB/CSO only)
Tuning Resolutions 10 kHz
Sweep Resolution 250 kHz maximum

Level Measurement

Range -40 to +60 dBmV
Resolution 0.1 dB
Accuracy ± 1.0 dB from -20 to +50°C^{1,2}
Log Linearity ± 0.5 dB¹
Flatness ± 0.5 dB³
Signal Types CW, single carrier, video
(single or dual audio/NICAM), audio, digital
Uncertainty for Digital Carrier
additional ± 0.5 dB (digital types 16/32/64/256 QAM,
QPR, QPSK, VSB, CAP-16, DVB/ACTS and TDMA
using zero-span spectrum mode) @280 kHz RBW

Carrier-to-Noise⁴

In-service measurement. Non-scrambled channels only. No preselection required for 78 channels or less. Best dynamic range at +10dBmV or higher input.

Range ≥ 52 dB¹
Resolution < 0.5 dB

Hum Measurement

In-service measurement. Carrier > 0 dBmV. Non-scrambled channels only
Range 0 to 10%
Resolution $< 0.2\%$
Accuracy $\pm 0.7\%$

Depth of Modulation

Assumes presence of white reference on any VITS line. Non-scrambled channels only. Audio demodulation of AM and FM carriers
Range 80 to 100%
Resolution $< 0.5\%$ at 85%
Audio Demodulation AM and FM Carriers

Tilt Measurement

Up to 9 pilot carriers or video channels with tilt and level measurements on the highest and lowest.
Hi-Lo Δ Resolution 0.1dB

Scan Mode

All video, audio, pilot carrier, and digital channel levels displayed.

Sweep Mode

SDA-5000 and 5500 only

Frequency Range 5-1000 MHz
Display Span user definable
Display Scale/Range 6 vertical divisions 1, 2, 5, or 10dB/division
Sweep Pulse Occupied Bandwidth 30 kHz
Stability ± 0.5 dB, normalized
(dependent on stability of referenced carriers)
Sweep Rate ~ 1 second (78 Channels, including
scrambled and digital signal types)
Channel Plan Templates (user editable)
China-1; China-2; France; HDTP-NL; Ireland; Japan;
Jerold; Jerold-HRC; Jerold-IRC; NCTA; NCTA-HRC; NCTA-SUB
NCTA-IRC; NTSC-Broadcast; OIRT-D/K; PL-B/G; PAL-UK

Spectrum Mode

Spans 3, 5, 10, 20, and 50 MHz (0.3, 0.5, 1, 2, and 5 MHz/div.)
Sweep Rates ~ 1 second updates with spans of 50, 20,
10 & 5 MHz ~ 1.7 second updates with 3 MHz span
Display Scaling and Range 0.5, 1, 2, 5, and 10 dB/div.
6 vertical divisions
Dwell programmable 0-25 ms
Spurious Free Dynamic Range 60 dB³
Sensitivity Without Preamp -40 dBmV 5 - 550 MHz
-35 dBmV 550 - 1000 MHz
Sensitivity With Preamp -50 dBmV 5 - 550 MHz
-45 dBmV 550 - 1000 MHz
Max. Level With Preamp +50 dBmV

Zero-Span Mode

Video BW > 1 MHz, 100 kHz, 10 kHz, 100 Hz
Resolution BW 2 MHz, 280 kHz, 30 kHz
Measurement BW Compensation programmable 1 kHz-99 MHz
Pulse Measurement Accuracy nominal level in 10 μ s
 ± 2 dB from nominal in 5 μ s
(> 1 MHz VBW, 280 kHz RBW)
Sweep Times 100 μ s to 20 s (1,2,5 settings)

Intermodulation Distortion (CSO/CTB)

Range⁵ ≥ 60 dB
Resolution 0.1 dB

Forward Transmitter

SDA-5000 with OPT 2/SDA-5500 only

Frequency Range 5 to 1,000 MHz
Output Level +20 to +50 dBmV
adjustable in 2 dB increments
Spectral Purity Hars -30 dBc
Spurs -35 dBc

Reverse Transmitter

Requires SDA-5000 with OPT 1 or 2

Frequency Range 5 to 1,000 MHz
Output Level +20 to +50 dBmV, adjustable
in 2dB increments
Spectral Purity Hars -30 dBc; Spurs -35 dBc

Telemetry

Frequency Range 5 to 1,000 MHz
Modulation FSK, 100 kHz deviation
Spectrum Required 1.0 MHz vacant bandwidth recommended
Spectral Purity Hars -30 dBc; Spurs -35 dBc

Data Storage

Files stored: Autotests, tilt, channel plans, scan and forward sweep. Also reverse sweep and reverse amp alignment on SDA-5000 with OPT 1 and/or 2. Spectrum mode (regular with max hold and CSO/CTB). Allocated on demand. The storage capability is simultaneous- more of one file type can be "traded" for less of another. All files stored as database, not as screen picture. Typical mix of files for 78-channel plan 8 channel plans, 16 sweep references 80 sweep traces; 40 scan files 20 spectrum displays; 20 autotests

Serial Interface

RS232; Epson, IBM, Seiko and Diconix Printers

Input Configuration

Connector Type 75 Ω Type F Female
(Optional 75 Ω Type BNC Female)
Maximum Sustained Voltage AC 100V DC 140V

General

Display 320x240 dot matrix LCD, selectable back light
SDA-5000 only
 Dimensions 15.2 x 27.9 x 8.9cm
 (6"x11"x3.5")
 Weight 2.3 kg (5.1lbs)
 (with OPT.1 or 2, 2.5 kg, 5.5lbs)
 Temperature Range Operating -20 to +47°C (-4 to 117°F)
SDA-5500 and SDA-5510 only
 Dimensions 48.3 x 13.3 x 35.6cm
 (19"x5.25"x14")
 Weight 6.8 kg (15lbs)
 Temperature Range Operating 0 to +50°C (32 to 120°F)

Power Sources

Battery Extended-life replaceable nickel metal
 hydride, 12V/3.5A-hr 4 hours cont. use on a single charge
 AC Line (SDA-5000)
 Charger Input 100-250 VAC, 50 - 60 Hz, 0.5A
 Charger Output Aux out 16V @ 750 mA
 Charge 15V @ 750 mA
 AC Line (SDA-5500) 100 to 265 to 63 Hz ~ 100 VAC
 47 to 63 Hz ~100VA

Notes

- 1) Typical Specifications
- 2) Relative to 25°C
- 3) @25°C and +20dBmV

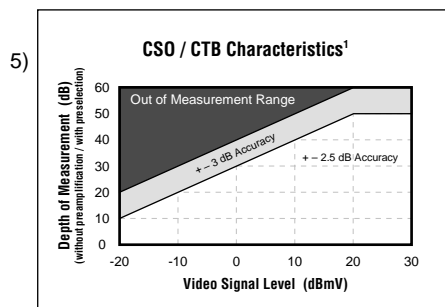
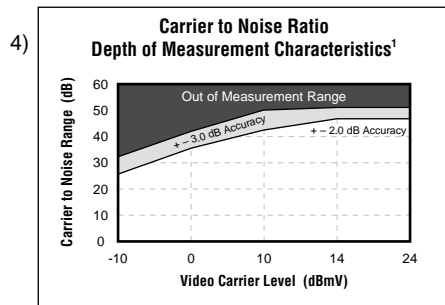

PathTrak Field View (OPT 3 required) SDA-5000 and SDA-5500 only

Update Rate 2x/second (remote trace)
 ~1x/second (local trace)
 Display Scaling5/1/2/5/10/20dB/div.
 Selectable Nodes 14 (selectable via PathTrak HCU)

QAM View Option (OPT 4)—PRELIMINARY

The QAM Analyzer Option (QAM View) can be factory installed in any new or existing SDA-5000 instrument. The specifications and features are in addition to the standard measurement features of the SDA-5000. When ordering, please specify OPT 4A for 8MHz, DVB-C, ITU-T J.83 Annex A, or OPT 4B for 6MHz, DVS-031, ITU-T J.83 Annex B.

Modulation Type

. 64/256 QAM, DVB-C, ITU-T J.83 Annex A (OPT 4A)
 64/256 QAM, DVS-031, ITU-T J.83 Annex B (OPT 4B)

Measurable Input Range (Lock Range)

64 QAM. -20 to +50 dBmV (typical)
 256 QAM. -15 to +50 dBmV (typical)

Frequency Tuning

50 to 860 MHz (Digital QAM mode)
 Resolution 25 kHz

MER (Modulation Error Ratio)

64 QAM/OPT 4A. 22-35 dB
 256 QAM/OPT 4A. 30-35 dB
 64 QAM/OPT 4B. 21-35 dB
 256 QAM/OPT 4B. 28-35 dB
 Accuracy. ± 1.5dB

EVM (Error Vector Magnitude)

64 QAM/OPT 4A 1.2% - 5.2%
 256 QAM/OPT 4A 1.1% - 2.0%
 64 QAM/OPT 4B 1.2% - 5.2%
 256 QAM/OPT 4B 1.1% - 2.5%
 Accuracy 64 QAM/OPT 4A and 4B ± 0.4% (1.2% - 2.0%)
 ± 1.0% (2.1% - 5.2%)
 Accuracy 256 QAM/OPT 4A and 4B. ± 0.5% (1.1% - 2.5%)

BER (Bit Error Rate)

64 QAM Pre-FEC/OPTs 4A and 4B 10⁻⁴ to 10⁻⁹
 64 QAM Post-FEC/OPTs 4A and 4B. 10⁻⁴ to 10⁻⁹
 256 QAM Pre-FEC/OPT 4A 10⁻⁴ to 10⁻⁶
 256 QAM Post-FEC/OPT 4A 10⁻⁴ to 10⁻⁹
 256 QAM Pre-FEC/OPT 4B 10⁻⁴ to 10⁻⁸
 256 QAM Post-FEC/OPT 4B 10⁻⁴ to 10⁻⁹

Measurable QAM Ingress

-25 to -40 dBc
 Accuracy ± 1.5 dB

Channel Bandwidth

8 MHz (OPT 4A); 6 MHz (OPT 4B)

Zero Span Spectrum

(Standard Feature - See SDA-5000 specifications)

Graphic Display

Digital summary (including MER/EVM, Pre/Post FEC BER, Equalizer Stress, Carrier Offset, Symbol Rate) with limit/margin test results. IQ constellation with zoom. Adaptive Equalizer Display (8 feed forward/24 feedback), Frequency Response, Group Delay. Ingress/Noise Under the Carrier.

Power Source

Note: Option powered from SDA-5000 nickel metal hydride battery. Operating time is specified for continuous use in QAM View mode. Option includes high output charger.

Charge Time ~4 hours
Operating Time 2.5 hours continuous use (typical)

Universal AC Charger/Adapter

Input 100-250 VAC, 50-60 Hz, 0.5A
Output. Charge15V @ 750 ma

Physical

Dimensions (total SDA-5000 size after option installation)
15.2 x 26.7 x 10.8 cm
6" x 10.5" x 4.25"
Weight (total SDA-5000 weight after option installation)
Approx. 3.5 kg (7.7 lbs)

Operating Temperature Range -20 to 45°C (-4 to 113°F)

Wavetek Wandel Goltermann Sales Offices

North America

1030 Swabia Court
P.O. Box 13585
Research Triangle Park, NC
27709-3585
Tel. +1 919 941-5730
Fax +1 919 941-5751

Latin America

Av. Eng. Luis Carlos Berrini,
936-8/9. andar
04571-000 Sao Paulo, SP
Brazil
Tel. +55 11 5503 3800
Fax +55 11 5505 1598

Asia-Pacific

PO Box 141
South Melbourne, Victoria
3205
Australia
Tel. +61 3 9690 6700
Fax +61 3 9690 6750

West Europe

Arbachtalstrasse 6
D-72800 Eningen u.A.
Germany
Tel. +49 7121 86 2222
Fax +49 7121 86 1222

Internet Address

www.wwgsolutions.com

East Europe

Postfach 13
Elisabethstrasse 36
A-2500 Baden
Austria
Tel. +43 2252 85521 0
Fax +43 2252 80727

CIS Countries

1st Neopalimovskiy per.
15/7 (4th floor)
119121 Moscow
Russia
Tel. +7 095 248 2508
Fax +7 095 248 4189

Local Sales Office:

