

DFB-1550H-PM

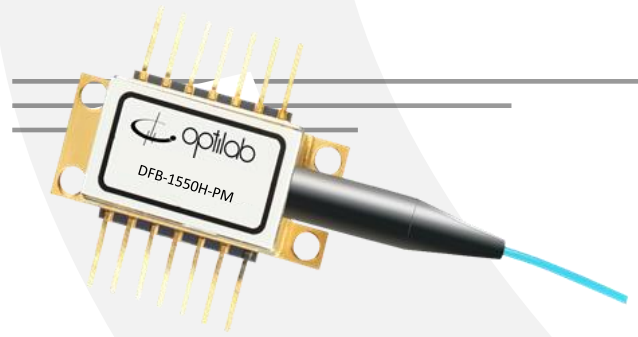

DEVICE

DFB Laser, 1550 nm, Up to 40 mW, PM Output, DM Capable

OVERVIEW

The Optilab DFB-1550H-PM is a single frequency laser coupled with Polarization Maintaining fiber. Built with Distributed Feed-Back Grating (DFB) as cavity reflector, it provides a pure, single longitudinal mode, and extremely stable wavelength source. This laser diode is fabricated with Multiple Quantum Well (MQW) for excellent reliability and stability. It can be used either in CW operation for seeding the external modulation and coherence interferometry, or directly modulated for signal transmission. This MQW DFB laser features 40 mW of output optical power, high Side Mode Suppression Ratio (SMSR). The standard 14-pin butterfly integrates TEC, thermistor, monitor PD and an output isolator. Contact Optilab for more information.

FEATURES

- Polarization maintaining output
- Up to 40 mW output power
- Low RIN noise, -145 dB/Hz max.
- Wavelengths Range to select: from 1549 nm to 1553 nm
- Built in TEC, Thermistor & Monitor PD
- Mode hop free version available

USE IN

- Dense Wavelength Division Multiplex (DWH)
- RF over Fiber (RToF)
- Hybrid Fiber-Coaxial (HFC)
- General laboratory and research use
- Direct Modulation

FUNCTIONAL DIAGRAM

Pin#	Desc	Pin#	Desc
1	Thermistor	8	Case Ground
2	Thermistor	9	Case Ground
3	LD- (Bias)	10	NC
4	PD+	11	LD+
5	PD-	12	LD RF -
6	TEC+	13	LD+
7	TEC-	14	NC

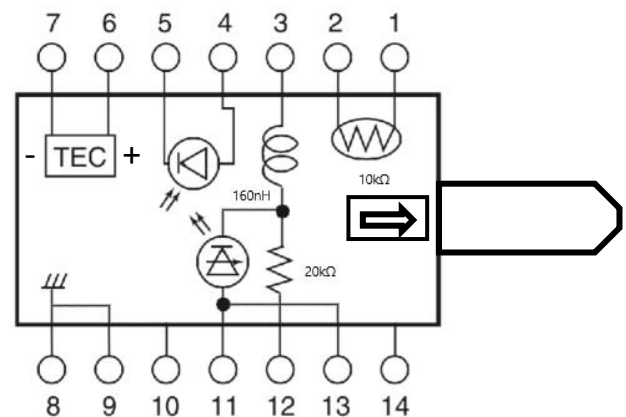

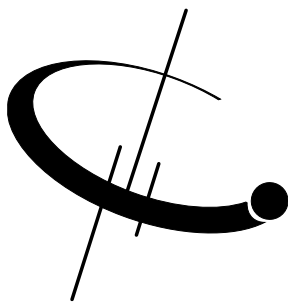

DFB-1550H-PM

SPECIFICATIONS

Wavelength Range	1549nm-1553nm
Wavelength Accuracy	±2 nm
Wavelength Tuning	± 1.5 nm
Optical Output Power	Up to 40 mW
Operating Current	650 mA
Forward Voltage	2.5 V typ.
Series Resistance	25 Ω typ.
Threshold Current	25 mA typ.

GENERAL

Monitor Current	0.10 mA min., 1.0 mA max.
Photodiode Dark Current	2 nA typ., 100 nA max.
Side Mode Suppression	40 dB min.
Linewidth	3 MHz max
3 dB S21 Bandwidth	2 GHz Min.
Optical Isolation	35 dB typ.
Relative Intensity Noise	-160 dB/Hz max.
Polarization Extinction Ratio	20 dB typ.

MECHANICAL

Operating Temperature	-10°C to +60 °C
Storage Temperature	-40°C to +70 °C
Operating Humidity	95% @ < 30 °C
Optical Fiber Type	PANDA PM
Optical Connector	FC/APC, other available

TEC AND THERMISTOR CHARACTERISTICS

TEC Current	1.0 A max.
TEC Voltage	2.4 V max.
TEC Resistance	2.4 Ω typ.
Thermistor Resistance	10 +/- 0.5 kOhm @ 25°C, NTC
Thermistor B Constant	3,270 K min., 3,450 K typ., 3,630 K max.

ABSOLUTE MAXIMUM RATING

Reverse Voltage	2 V
Operating Current	400 mA
PD Reverse Voltage	20 V
PD Forward Current	10 mA
TEC Voltage	4 V
TEC Current	4 A



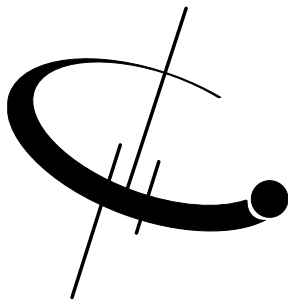

DFB-1550H-PM

OPTIONS

DFB-XXXXH-PM-YY

XXXX: Wavelength in nm
:1549 ~ 1553

YY: Output Power in mW
:Up to 40

MECHANICAL DRAWING

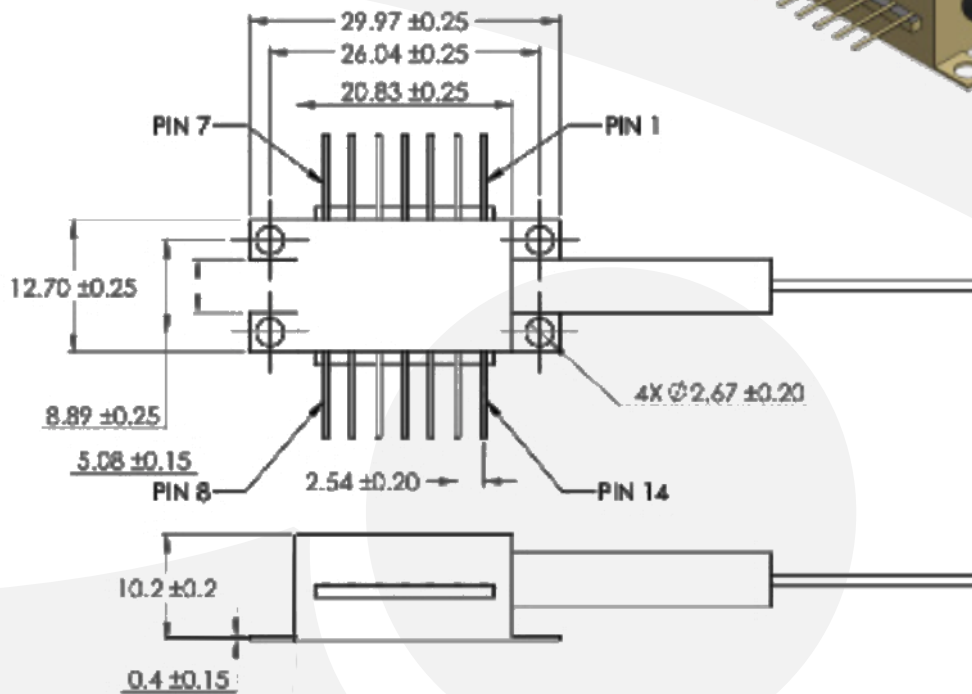

Unit: mm

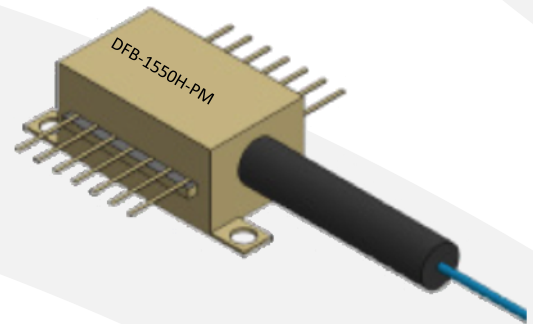

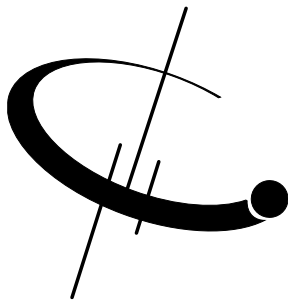

DFB-1550H-PM

AVAILABLE ACCESSORIES

UNIVERSAL LASER DIODE CONTROLLER (ULDC)



ULDC is a fully integrated laser diode controller with precise current and temperature setting. With a Zero Insertion Force (ZIF) adaptor, ULDC can be used with all 14 pin laser diodes. It also features ~2MHz direct modulation with external board

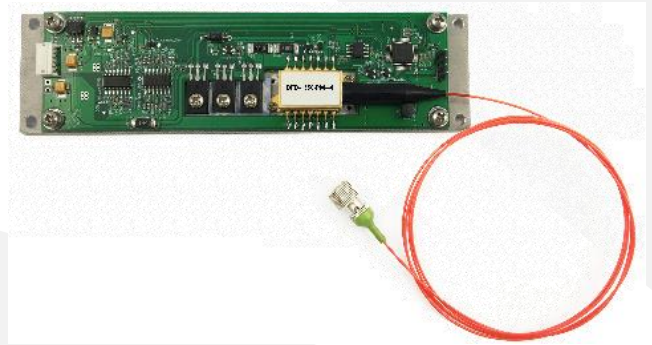

DFB-1550H-PM can be ordered as DFB- PM-M, which allows DFB laser's operating temperature and output power precisely controlled to ensure constant wavelength and power stability. It can be used for module level integration system.

