

PM-1550-5-LD



DEVICE

5 GHz 1550 nm Phase Modulator

OVERVIEW

The Optilab PM-1550-5-LD phase modulator is a high performance, 5 GHz LiNbO3 modulator. This modulator can provide phase modulation with a low driving voltage. Its low insertion loss provides for its maximum transmission power. The PM-1550-5-LD modulator uses polarization maintaining (PM) input and output fibers, making it easy to integrate with other optical components. Contact Optilab for more information.

FEATURES

- 5 GHz Bandwidth
- X-cut APE Process
- Low Optical Loss
- Low Drive Voltage
- 1525 nm to 1565 nm
- Minimal Back Reflections
- Polarization Maintaining

USE IN

- Coherent Communications
- Optical Chirping
- Optical Sensing
- FM Spectroscopy
- Frequency Shifting
- Laser Linewidth Broadening

FUNCTIONAL DIAGRAM

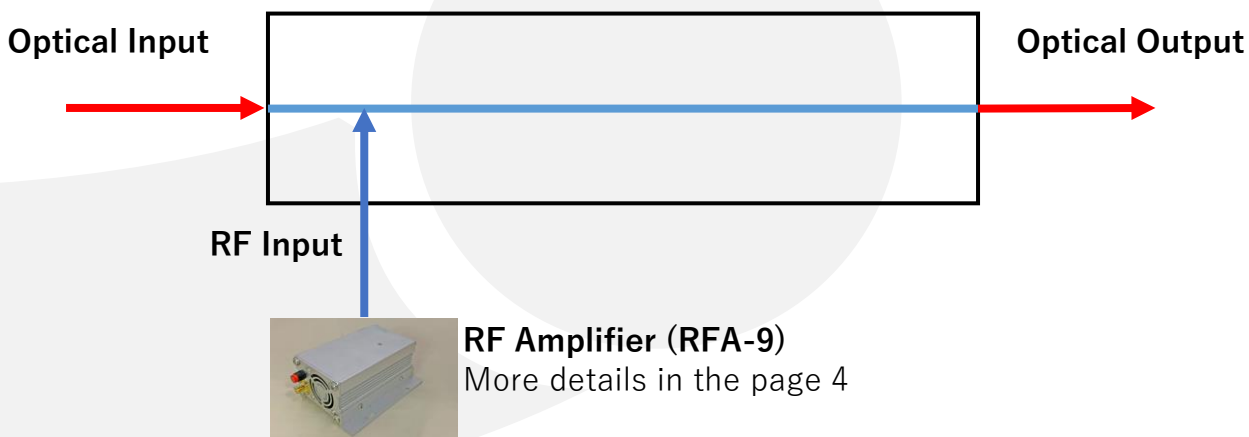

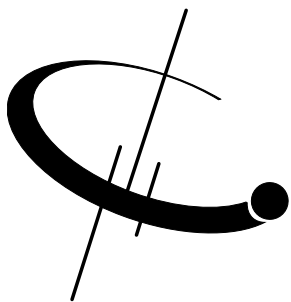

PM-1550-5-LD

SPECIFICATIONS

Input Optical Power	40 mW max.
Operating Wavelength	1525 nm to 1570 nm
Insertion Loss	3 dB typ., 3.5 dB max.
Polarization Extinction Ratio	≥ 21 dB
Optical Return Loss	≥ 30 dB
S21 Bandwidth	5 GHz typ. @ -3 dB
S11 Return Loss	≤ -10 dB @ 5 GHz
$V\pi$	5 V typ. @ 1 GHz
RF Input Power	+30 dBm max.
Impedance	50 Ω typ.

GENERAL

Operating Temperature	-55°C to +75°C
Storage Temperature	-60°C to +90°C
Operating Humidity	0% to 90% Relative Humidity
Input/Output Fiber	Panda - PM1550
Input/Output Connector	PM FC/APC, request for others
RF Port Connectors	K Connector
Cabling	900 μ m tubing
Dimensions	3.783" x 0.981" x 0.640"

MECHANICAL

S21 CHARACTERISTICS

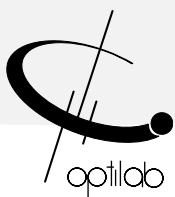
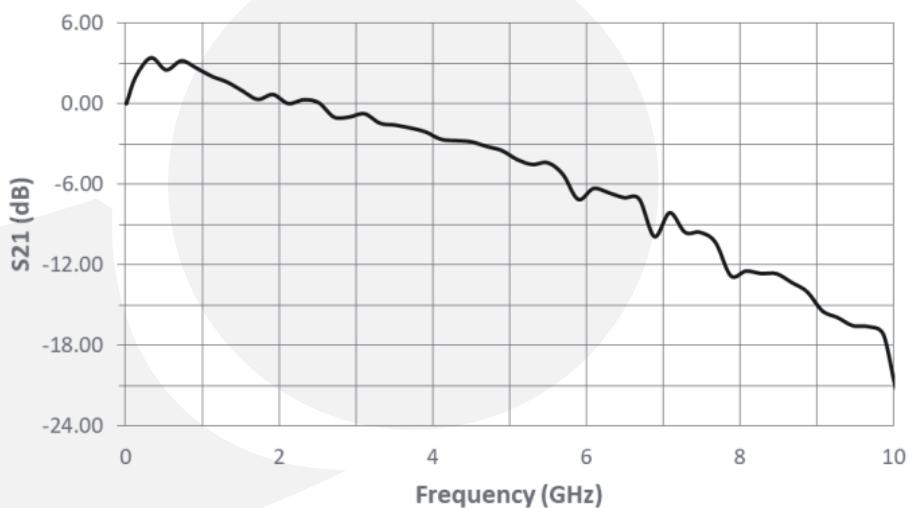

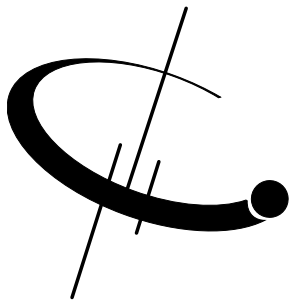

PM-1550-5-LD

S11 CHARACTERISTICS

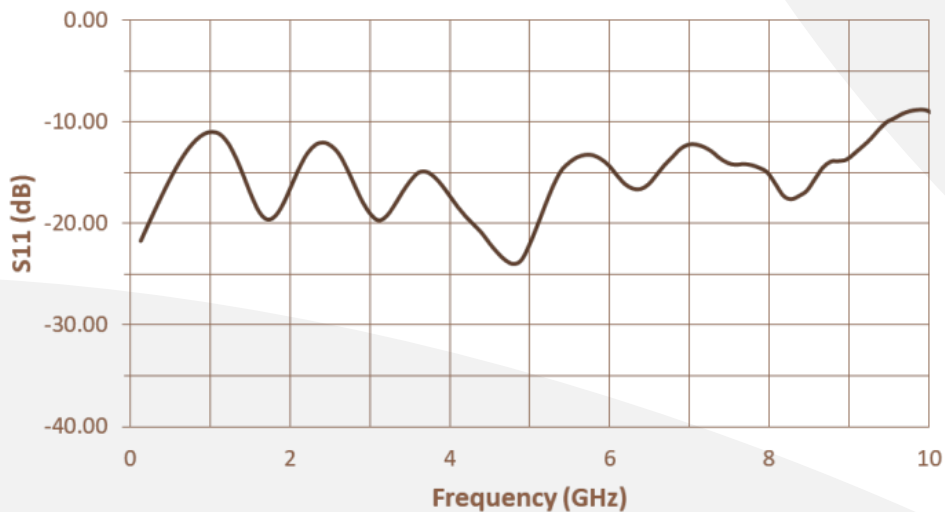

MECHANICAL DRAWING

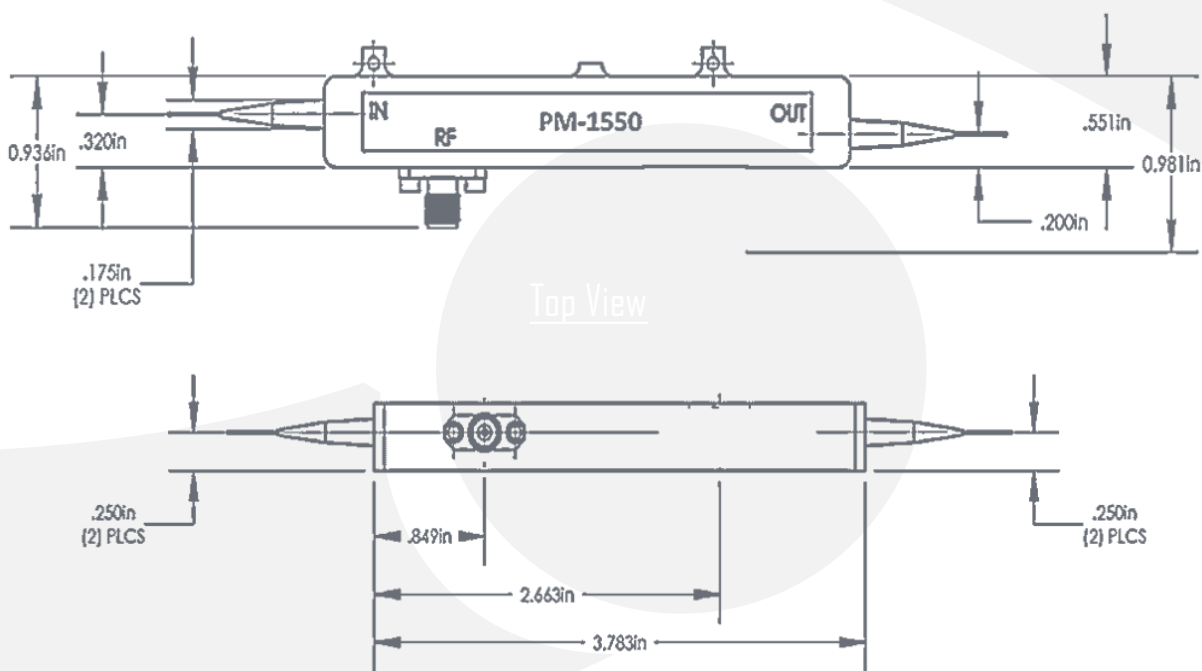

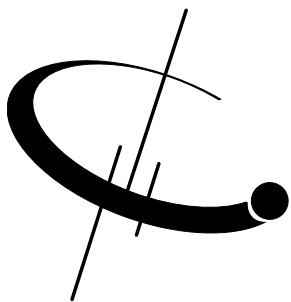

PM-1550-5-LD

Available Accessories

- **RFA-9**



The Optilab RFA-9 is a high gain RF amplifier module with 30dBm output and 10V peak to peak. It offers cost-effective solutions for microwave and analog link. Please contact Optilab for more detail.

